

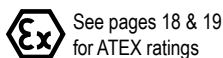

**SERVICE & OPERATING MANUAL**  
**Original Instructions**  
**Model HDB2 Type 3**



## Table of Contents

Engineering Data and Performance Curve.....	1
Explanation of Pump Nomenclature and Temperature Limitations.....	2
Dimensions.....	3
Principle of Operation.....	4
Installation and Start-Up.....	4
Air Supply.....	4
Installation Guide.....	5
Air Inlet & Priming.....	6
Air Exhaust.....	6
Between Uses.....	6
Check Valve Servicing.....	6
Diaphragm Servicing.....	6
Air Valve Lubrication.....	7
ESADS+Plus®: Externally Serviceable Air Distribution System.....	7
Pilot Valve.....	8
Pilot Valve Actuator.....	8
Service Instructions: Troubleshooting.....	9
Warranty.....	9
Recommended Accessories, Available Service Kits.....	9
Important Safety Information.....	10
Recycling.....	10
Grounding The Pump.....	11
Material Codes.....	12
Composite Repair Parts List.....	13-15
Composite Repair Drawing.....	16
CE Declaration of Conformity - Machinery.....	17
CE Declaration fo Conformity - ATEX.....	18
Explanation of ATEX Certification.....	19



**WARREN  
RUPP®**

Quality System  
ISO9001 Certified

Environmental  
Management System  
ISO14001 Certified

**IDEX**  
FLUID & METERING

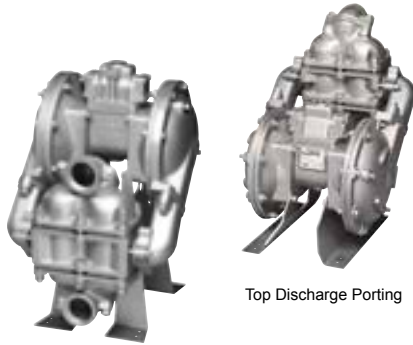

Bottom Discharge Porting

Top Discharge Porting

**SANDPIPER®**  
A WARREN RUPP PUMP BRAND

**HDB2 Type 3  
Heavy Duty Ball Valve  
Air-Operated  
Double Diaphragm Pump**

ENGINEERING, PERFORMANCE  
& CONSTRUCTION DATA



See pages 18 & 19  
for ATEX ratings

INTAKE/DISCHARGE PIPE SIZE	CAPACITY	AIR VALVE	SOLIDS-HANDLING	HEADS UP TO	DISPLACEMENT/STROKE
2" (50mm) NPT (F)	0 to 135 gallons per minute (0 to 511 liters per minute)	No-lube, no-stall design	Up to 3/8 in. (9mm)	125 psi or 289 ft. of water (8.8 Kg/cm <sup>2</sup> or 88 meters)	.43 Gallon / 1.63 liter

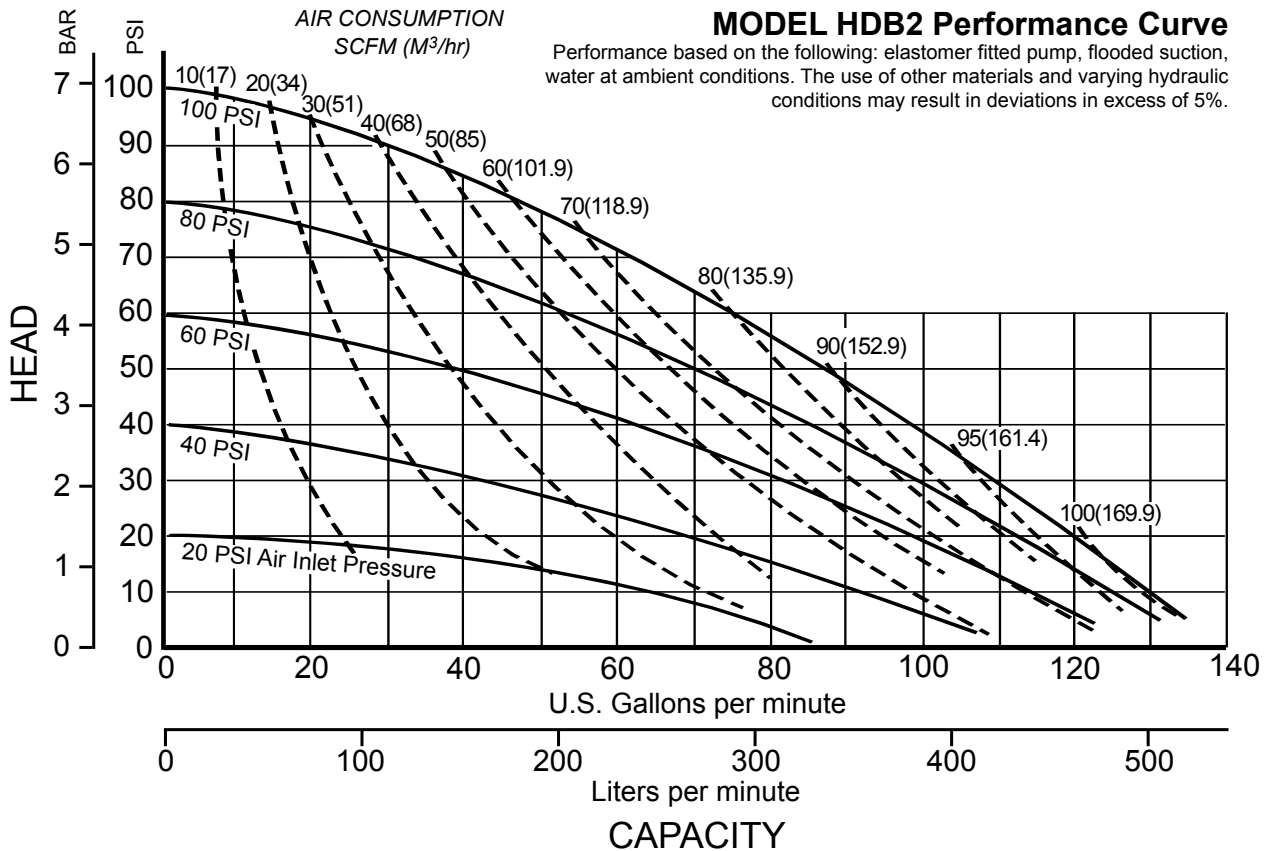

SANDPIPER® pumps are designed to be powered only by compressed air.

# Explanation of Pump Nomenclature, HDB2

Your Model #: \_\_\_\_\_  
 (fill in from pump nameplate)

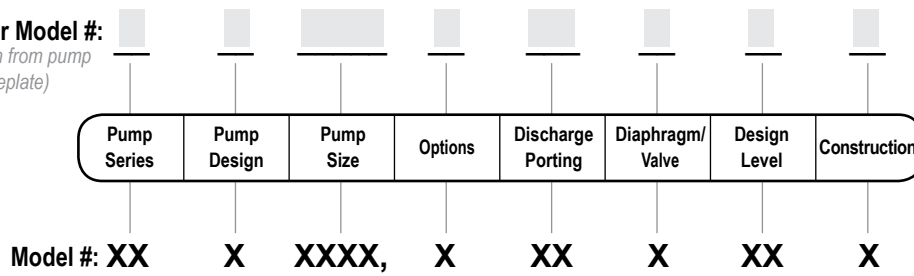

## Pump Series

**S** SANDPIPER®

## Pump Design

**B** Solid Ball

## Pump Size

**2** 2"

## Discharge Porting Position

**D** Bottom

**S** Side

**ET** Dual Top

**ES** Dual Side

## Diaphragm Check Valve Materials

**B** Nitrile

**C** FKM with PTFE

**F** FDA Accepted White Nitrile

**GN** Neoprene Backup with PTFE Overlay and PTFE Check Balls

**GR** Hytrel Backup w/ PTFE Overlay/PTFE Balls

**GZ** PTFE/Nitrile Bonded

One-Piece/PTFE Balls

**H** EPDM with PTFE

**N** Neoprene

**R** Hytrel

**S** Santoprene

**U** Santoprene with PTFE

**V** FKM

## Design Level

**3**

## Construction

**A** Aluminum Wetted, Aluminum Air

**SI** Stainless Steel Wetted, Cast Iron Air

**SS** Stainless Steel Wetted, Aluminum Air

**HC** Alloy-C Wetted, Aluminum Air

**HI** Alloy-C Wetted, Cast Iron Air

## Options

**P1** Intrinsically Safe ATEX Compliant Pulse Output

Your Serial #: (fill in from pump nameplate) \_\_\_\_\_



II 1 G c T5  
 II 3/1 G c T5  
 II 1 D c T100oC  
 I M1 c  
 I M2 c

Models equipped with Cast Iron, Stainless Steel, or Alloy C wetted parts, and Cast Iron mid-section parts. See page 19 for ATEX Explanation of EC-Type Certificate.



II 2 G c T5  
 II 3/2 G c T5  
 II 2 D c T100oC

All models, including pumps equipped with Aluminum wetted and midsection parts. See page 19 for ATEX Explanation of Type Examination Certificate.

Maximum and Minimum Temperatures are the limits for which these materials can be operated. Temperatures coupled with pressure affect the longevity of diaphragm pump components. Maximum life should not be expected at the extreme limits of the temperature ranges.

Materials	Operating Temperatures	
	Maximum	Minimum
<b>Nitrile</b> General purpose, oil-resistant. Shows good solvent, oil, water and hydraulic fluid resistance. Should not be used with highly polar solvents like acetone and MEK, ozone, chlorinated hydrocarbons and nitro hydrocarbons.	190°F 88°C	-10°F -23°C
<b>EPDM</b> Shows very good water and chemical resistance. Has poor resistance to oil and solvents, but is fair in ketones and alcohols.	280°F 138°C	-40°F -40°C
<b>NEOPRENE</b> All purpose. Resistant to vegetable oils. Generally not affected by moderate chemicals, fats, greases and many oils and solvents. Generally attacked by strong oxidizing acids, ketones, esters, nitro hydrocarbons and chlorinated aromatic hydrocarbons.	200°F 93°C	-10°F -23°C
<b>HYTREL®</b> Good on acids, bases, amines and glycols at room temperature.	220°F 104°C	-20°F -29°C
<b>PTFE</b> Chemically inert, virtually impervious. Very few chemicals are known to react chemically with PTFE: molten alkali metals, turbulent liquid or gaseous fluorine and a few fluoro-chemicals such as chlorine trifluoride or oxygen difluoride which readily liberate free fluorine at elevated temperatures.	220°F 104°C	-35°F -37°C
<b>FKM (Fluorocarbon)</b> shows good resistance to a wide range of oils and solvents; especially all aliphatic, aromatic and halogenated hydrocarbons, acids, animal and vegetable oils. Hot water or hot aqueous solutions (over 70°F) will attack FKM.	350°F 177°C	-40°F -40°C
<b>Santoprene®</b> Injection molded thermoplastic elastomer with no fabric layer. Long mechanical flex life. Excellent abrasion resistance.	275°F 135°C	-40°F -40°C
‡ <b>CF-8M Stainless Steel</b> equal to or exceeding ASTM specification A743 for corrosion resistant iron chromium, iron chromium nickel, and nickel based alloy castings for general applications. Commonly referred to as 316 Stainless Steel in the pump industry.		
<b>ALLOY C CW-12MW</b> equal to or exceeding ASTM A494 specification for nickel and nickel alloy castings.		

For specific applications, always consult "Chemical Resistance Chart" Technical Bulletin

# Dimensions: HDB2

Dimensions are  $\pm 1/8"$   
 Figures in parenthesis = millimeters

## TOP DISCHARGE PORTING

\* Indicates dimensions with suction and discharge ports rotated 180° to a vertical position.

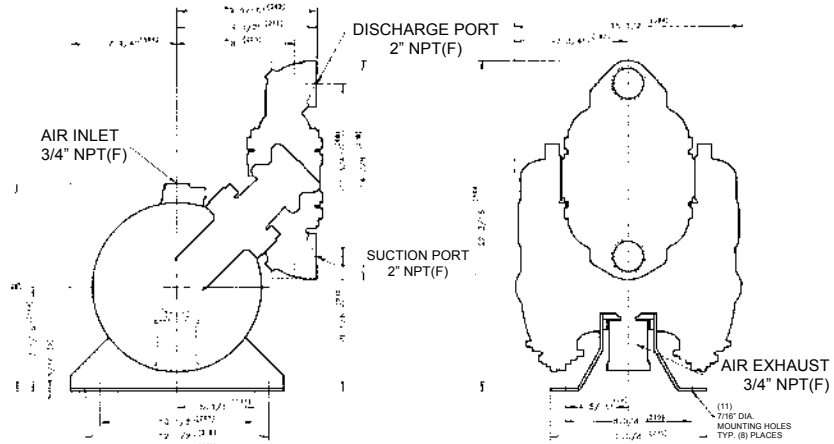

\* INDICATES DIMENSIONS WITH SUCTION AND DISCHARGE PORTS ROTATED 180° TO A VERTICAL POSITION.

Dimension	A	B
Standard Pump	23 1/4" (590)	14 1/16" (357)
Pulse Output Kit	23 13/16" (605)	14 5/8" (371)

## BOTTOM DISCHARGE PORTING

\* Indicates dimensions with suction and discharge ports rotated 180° to a vertical position.

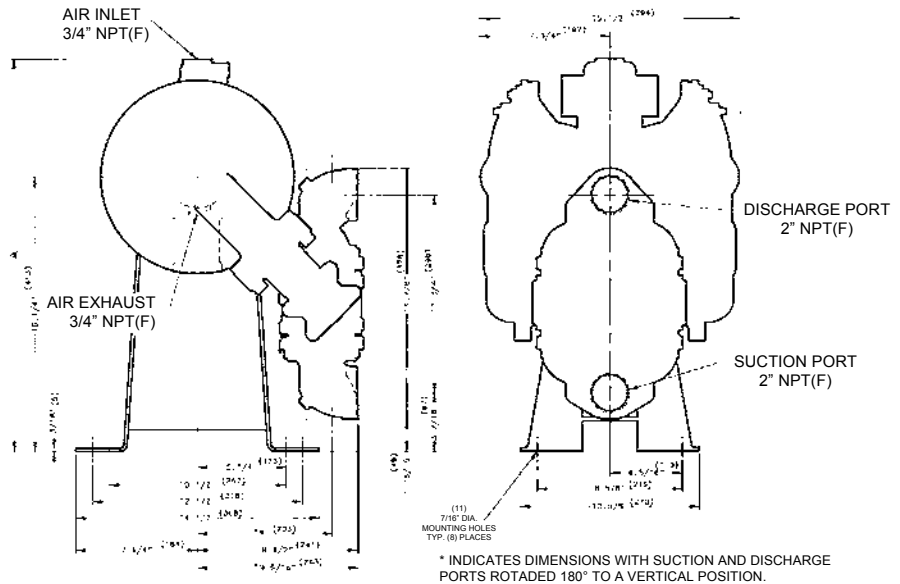

\* INDICATES DIMENSIONS WITH SUCTION AND DISCHARGE PORTS ROTATED 180° TO A VERTICAL POSITION.

**WARREN  
RUPP®****IBEX**  
FLUID & METERING**SANDPIPER®**  
A WARREN RUPP PUMP BRANDSee pages 18 & 19  
for ATEX ratings**SERVICE & OPERATING MANUAL**  
Original Instructions  
**Model HDB2 Type 3****PLEASE NOTE!**

The photos shown in this manual are for general instruction only. YOUR SPECIFIC MODEL MAY NOT BE SHOWN. Always refer to the parts list and exploded view drawing for your specific model when installing, disassembling or servicing your pump.

**PRINCIPLE OF PUMP OPERATION**

This ball check valve pump is powered by compressed air and is a 1:1 pressure ratio design. The pump is alternately pressurize through the inner side of one diaphragm chamber, while simultaneously exhausting the other inner chamber. Air pressure causes the diaphragms, (which are connected by a common rod,) to move endwise. Air pressure is applied over the entire surface of the diaphragm, while liquid is discharged from the opposite side. The diaphragm operates under a balanced condition during the discharge stroke, and the unit can be operated at discharge heads over 200 feet (61 meters) of water head.

The diaphragms are connected by a common rod, secured by plates to the center of the diaphragms. One diaphragm performs the discharge stroke, while the other is pulled to perform the suction stroke in the opposite chamber.

For maximum diaphragm life, keep the pump as close to the liquid being pumped as possible. Positive suction head in excess of 10 feet of liquid (3.048 meters) may require a back pressure regulating device. This will maximize diaphragm life.

Alternate pressuring and exhausting of the diaphragm chamber is performed by means of an externally mounted, pilot operated, four-way spool type air distribution valve. When the spool shifts to one end of the valve body, inlet air pressure is applied to one diaphragm chamber and the other diaphragm chamber exhausts air. When the spool shifts to the opposite end of the valve body, the porting of chambers is reversed. The air distribution valve spool is moved by an internal pilot valve which alternately pressurizes one side of the air distribution valve spool, while exhausting the other side. The pilot valve is shifted at each end of the diaphragm stroke by the diaphragm plate coming in contact with the end of the pilot spool. This pushes the pilot valve into position for shifting of the air distribution valve.

The chambers are manifolded together with a suction and discharge check valve for each chamber which maintains flow in one direction through the pump.

**INSTALLATION & START-UP**

Locate the pump as close to the product being pumped as possible. Keep suction line length and number of fittings to a minimum. Do not reduce line size.

For installations of rigid piping, short flexible sections of hose should be installed between pump and piping. This reduces vibration and strain to the piping system. A Warren Rupp Tranquilizer® surge suppressor is recommended to further reduce pulsation in flow.

This pump was tested at the factory prior to shipment and is ready for operation. It is self-priming from a dry start for suction lifts of 20 feet (6.096 meters) or less. For suction lifts exceeding 20 feet of liquid, fill the chambers with liquid prior to priming.

**AIR SUPPLY**

Air supply pressures cannot exceed 125 psi (8.61 bar). Connect the pump air inlet to an air supply of sufficient capacity and pressure required for desired performance. When the air line is solid piping, use a short length of flexible hose [not less than 3/4" (19mm) in diameter] between pump and piping to eliminate strain to pipes.

## INSTALLATION GUIDE Top Discharge Ball or Flap Valve Unit

Available from  
Warren Rupp

- ① Tranquilizer®/Surge Suppressor
- ② Filter/Regulator

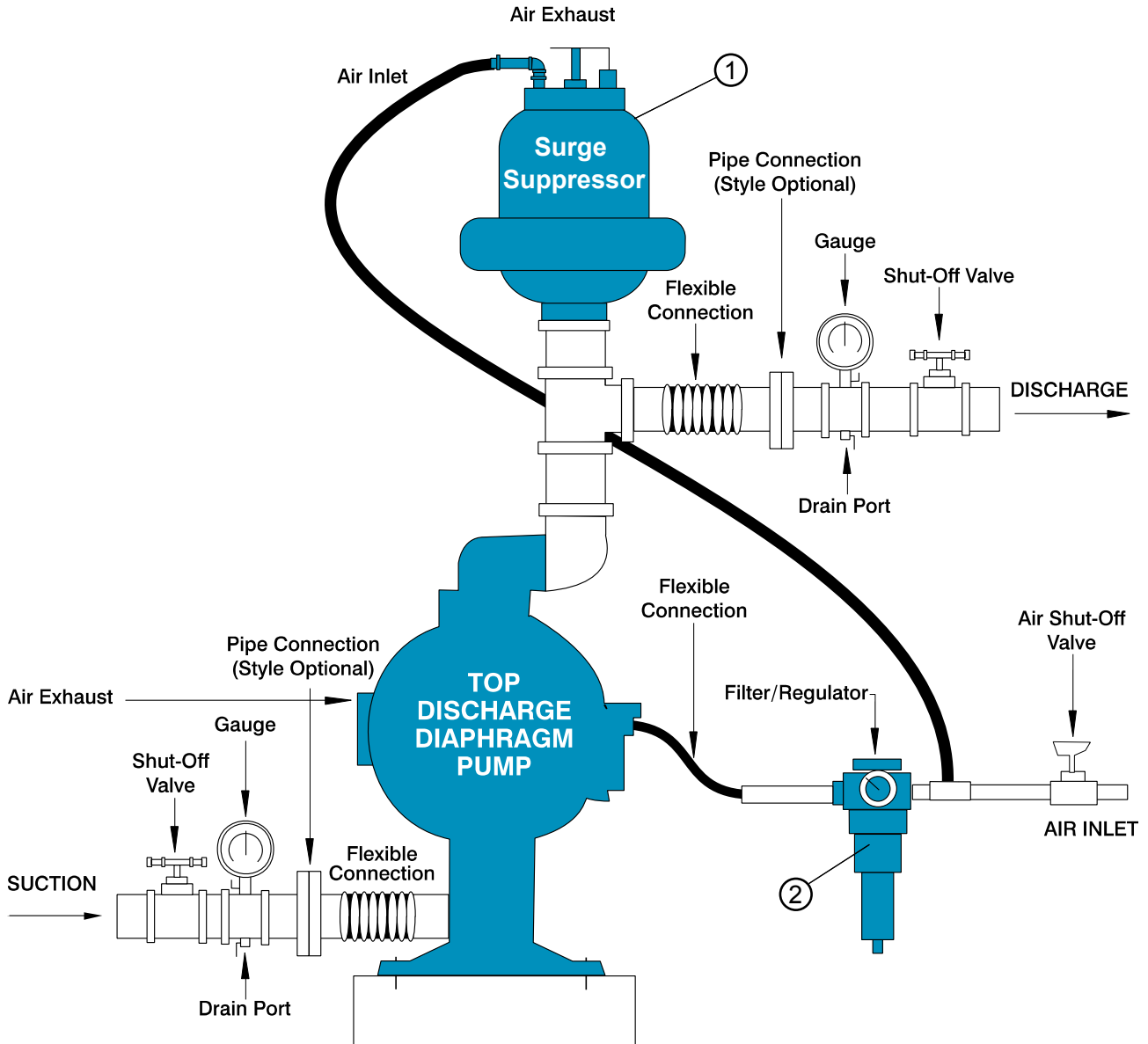
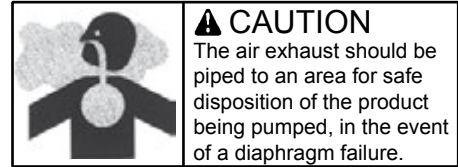

## AIR INLET & PRIMING

For start-up, open an air valve approximately 1/2" to 3/4" turn. After the unit primes, an air valve can be opened to increase flow as desired. If opening the valve increases cycling rate, but does not increase flow rate, cavitation has occurred, and the valve should be closed slightly.

For the most efficient use of compressed air and the longest diaphragm life, throttle the air inlet to the lowest cycling rate that does not reduce flow.

## AIR EXHAUST

If a diaphragm fails, the pumped liquid or fumes can enter the air end of the pump, and be exhausted into the atmosphere. When pumping hazardous or toxic materials, pipe the exhaust to an appropriate area for safe disposition.

This pump can be submerged if materials of construction are compatible with the liquid. The air exhaust must be piped above the liquid level. Piping used for the air exhaust must not be smaller than 1" (2.54 cm). Reducing the pipe size will restrict air flow and reduce pump performance. When the product source is at a higher level than the pump (flooded suction), pipe the exhaust higher than the product source to prevent siphoning spills.

Freezing or icing-up of the air exhaust can occur under certain temperature and humidity conditions. Use of an air dryer unit should eliminate most icing problems.

## BETWEEN USES

When used for materials that tend to settle out or transform to solid form, the pump should be completely flushed after each use, to prevent damage. Product remaining in the pump between uses could dry out or settle out. This could cause problems with valves and diaphragms at re-start. In freezing temperatures, the pump must be drained between uses in all cases.

## CHECK VALVE SERVICING

For best priming and most efficient pumping performance, it is important to maintain check valves and valve seats in good condition for proper sealing. Need for inspection or service of ball valves is usually indicated by poor priming, unstable cycling, reduced performance, or pump cycles but will not pump.

Inspection and service of check valves requires the removal of five hex nuts and one capscrew for each set of check valves (i.e., suction & discharge), providing access to the two ball valves and their valve seats. New ball valves are 3<sup>5</sup>/<sub>8</sub>" (9.21 cm) in diameter and will require replacement when worn to approximately 3<sup>3</sup>/<sub>8</sub>" (8.57 cm) diameter.

## DIAPHRAGM SERVICING

Need for inspection or service of diaphragm is usually indicated when unit pumps from one chamber only and air is discharged out pump discharge port or when liquid being pumped is discharged through air exhaust port.

To service diaphragms remove two capscrews which secure the chamber to the manifold assembly, and twelve hex nuts that secure the chamber to the main pump assembly. To remove diaphragms, loosen diaphragm assembly by turning it out of the diaphragm rod using a 1<sup>1</sup>/<sub>8</sub>" (2.857 cm) socket or wrench. Removal of opposite outer chamber will permit removal of second diaphragm assembly and diaphragm rod as a unit.

To remove the diaphragm from the diaphragm assembly, hold the diaphragm rod in a clamping device, making sure to protect the rod surface of shaft so as not to scratch or damage it in any way. With a wrench turn the diaphragm assembly out of the diaphragm rod. To disassemble the components, turn a 5/16-18 UNC capscrew by hand into the tapped hole in the inner diaphragm plate. This will keep the plate from turning while the capscrew is removed. To remove the capscrew, place the assembly in a vise so the two protruding ends of screws are loose in the vise jaws (approximately 7/8" apart). Turn the center screw loose from the back plate and the assembly will come apart.



## REASSEMBLY

All procedures for reassembling the pump are the reverse of the disassembly instructions with further instructions as shown:

The diaphragm assemblies are to be installed with the natural bulge outward or toward the head of the center screw. Make sure both plates are installed with outer radii against the diaphragm. After all components are in position in a vise and hand tight, set a torque wrench for 40 ft. pounds (54.23 Newton meters) using a  $1\frac{1}{8}$ " (2.857 cm) socket. After each diaphragm sub assembly has been completed, thread one assembly into the diaphragm rod. Make sure the 5/16-18 UNC capscrew has been removed from the inner plate and the diaphragm rod bumper is in place on the diaphragm rod.

Install this sub assembly into the pump and secure by installing the outer chamber in place and tightening the capscrews. This will hold the assembly in place while the opposite side is installed. Install the second diaphragm assembly into the diaphragm rod checking to see that the diaphragm rod bumper is in place. Tighten to 30 ft. lbs. (40.67 Newton meters) torque before installing the outer chamber in place. If the holes in the diaphragm flange do not align with the holes in the inner chamber flange, turn the diaphragm assembly in the direction of tightening to align the holes so that the capscrews can be inserted. This final torquing of the last diaphragm assembly will lock the two diaphragm assemblies together. Secure the last outer chamber by tightening down the securing nuts gradually and evenly. This tightening procedure should be done on both sides.

When reinstalling check valves, take care that the seat gaskets are aligned properly before securing porting flange in place.

### A Note about Air Valve Lubrication

The SANDPIPER pump's pilot valve and main air valve assemblies are designed to operate WITHOUT lubrication. This is the preferred mode of operation. There may be instances of personal preference, or poor quality air supplies when lubrication of the compressed air supply is required. The pump air system will operate with properly lubricated compressed air supplies. Proper lubrication of the compressed air supply would entail the use of an air line lubricator (available from Warren Rupp) set to deliver one drop of 10 wt., non-detergent oil for every 20 SCFM of air the pump consumed at its point of operation. Consult the pump's published Performance Curve to determine this.

It is important to remember to inspect the sleeve and spool set routinely. It should move back and forth freely. This is most important when the air supply is lubricated. If a lubricator is used, oil accumulation will, over time, collect any debris from the compressed air. This can prevent the pump from operating properly.

Water in the compressed air supply can create problems such as icing or freezing of the exhaust air causing the pump to cycle erratically, or stop operating. This can be addressed by using a point of use air dryer to supplement a plant's air drying equipment. This device will remove excess water from the compressed air supply and alleviate the icing or freezing problem.

### ESADS+Plus®: Externally Serviceable Air Distribution System

Please refer to the exploded view drawing and parts list in the Service Manual supplied with your pump. If you need replacement or additional copies, contact your local Warren Rupp Distributor, or the Warren Rupp factory Literature Department at the number shown below. To receive the correct manual, you must specify the MODEL and TYPE information found on the name plate of the pump.

The main air valve sleeve and spool set is located in the valve body mounted on the pump with four hex head capscrews. The valve body assembly is removed from the pump by removing these four hex head capscrews.

With the valve body assembly off the pump, access to the sleeve and spool set is made by removing four hex head capscrews (each end) on the end caps of the valve body assembly. With the end caps removed, slide the spool back and forth in the sleeve. The spool is closely sized to the sleeve and must move freely to allow for proper pump operation. An accumulation of oil, dirt or other contaminants from the pump's air supply, or from a failed diaphragm, may prevent the spool from moving freely.

This can cause the spool to stick in a position that prevents the pump from operating. If this is the case, the sleeve and spool set should be removed from the valve body for cleaning and further inspection.

Remove the spool from the sleeve. Using an arbor press or bench vise (with an improvised mandrel), press the sleeve from the valve body. Take care not to damage the sleeve. At this point, inspect the o-rings on the sleeve for nicks, tears or abrasions. Damage of this sort could happen during assembly or servicing. A sheared or cut o-ring can allow the pump's compressed air supply to leak or bypass within the air valve assembly, causing the pump to leak compressed air from the pump air exhaust or not cycle properly. This is most noticeable at pump dead head or high discharge pressure conditions. Replace any of these o-rings as required or set up a routine, preventive maintenance schedule to do so on a regular basis. This practice should include cleaning the spool and sleeve components with a safety solvent or equivalent, inspecting for signs of wear or damage, and replacing worn components.

To re-install the sleeve and spool set, lightly lubricate the o-rings on the sleeve with an o-ring assembly lubricant or lightweight oil (such as 10 wt. air line lubricant). Press the set into the valve body easily, without shearing the o-rings. Re-install one end cap, gasket and bumper on the valve body. Using the arbor press or bench vise that was used in disassembly, press the sleeve back into the valve body. You may have to clean the surfaces of the valve body where the end caps mount. Material may remain from the old gasket. Old material not cleaned from this area may cause air leakage after reassembly. Take care that the bumper stays in place allowing the sleeve to press in all the way. Re-install the spool, the opposite end cap, gasket and bumper on the valve body. After inspecting and cleaning the gasket surfaces on the valve body and intermediate, re-install the valve body on the pump using new gaskets. Tighten the four hex head capscrews evenly and in an alternating cross pattern.

## **PILOT VALVE**

The pilot valve assembly is accessed by removing the main air distribution valve body from the pump and lifting the pilot valve body out of the intermediate housing.

Most problems with the pilot valve can be corrected by replacing the o-rings. Always grease the spool prior to inserting it into the sleeve. If the sleeve is removed from the body, reinsertion must be at the chamfered side. Grease the o-rings to slide the sleeve into the valve body. Securely insert the retaining ring around the sleeve. When reinserting the pilot valve, push both plungers (located inside the intermediate bracket) out of the path of the pilot valve spool ends to avoid damage.

## **PILOT VALVE ACTUATOR**

Bushings for the pilot valve actuators are threaded into the intermediate bracket from the outside. The plunger may be removed for inspection or replacement. First remove the air distribution valve body and the pilot valve body from the pump. The plungers can be located by looking into the intermediate. It may be necessary to use a fine piece of wire to pull them out. The bushing can be turned out through the inner chamber by removing the outer chamber assembly. Replace the bushings if pins have bent.

## TROUBLESHOOTING

**PROBLEM:** Pump cycles but will not pump. (Note: higher suction lifts require faster cycling speed for priming.)

**POSSIBLE CAUSES:**

- A. Air leak in suction line.
- B. Excessive suction lift.
- C. Check valve not closing.
- D. Leakage at joint of suction manifold or elbow flange.
- E. Suction line plugged.
- F. Diaphragm ruptured.

**PROBLEM:** Pump will not cycle. (Note: Always disconnect air supply to relieve air pressure before disassembling any portion of pump.)

**POSSIBLE CAUSES:**

- A. Discharge hose or line plugged, or discharge head requirement greater than air supply pressure. (Disconnect discharge line to check.)
- B. Spool in air distribution valve not shifting. (Remove end cap and check spool — must slide freely.)
- C. Diaphragm ruptured. (Air will escape out discharge line in this case.)
- D. Blockage in diaphragm chamber preventing movement. (Shut off air supply and reopen after pressure is relieved.)
- E. Plugged or dirty exhaust muffler.

**PROBLEM:** Uneven discharge flow. (Indicates one chamber not operating properly.)

**POSSIBLE CAUSES:**

- A. Check valve not sealing properly in one chamber.
- B. Diaphragm failure in one chamber.
- C. Air leak at suction manifold joint or elbow flange one side.
- D. Plugged or dirty muffler.

For additional information, see the Warren Rupp Troubleshooting Guide.

## WARRANTY:

This unit is guaranteed for a period of five years against defective material and workmanship.

### RECOMMENDED WARREN RUPP ACCESSORIES TO MAXIMIZE PUMP PERFORMANCE:

- **Tranquilizer® Surge Suppressor:** For nearly pulse-free flow.
- **Warren Rupp Filter/Regulator:** For modular installation and service convenience.
- **Warren Rupp Speed Control:** For manual or programmable process control. Manual adjustment or 4-20mA reception.

*For more detailed information on these accessories,  
contact your local Warren Rupp Factory-Authorized Distributor,  
or Warren Rupp corporate headquarters.*

#### Available Service Kits

Part No.	Description
476-247-000	Air End Kit Seals, O-Rings, Gaskets, Sleeve and Spool Set, Plungers, Bushings, Pilot Valve Assembly
476-245-354	Santoprene Diaphragms, Check Balls, Gaskets, Seals, Nitrile O-Rings
476-245-360	Nitrile Diaphragms, Weighted Check Balls, O-Rings, Gaskets, Seals, Wear Pads
476-245-364	EPDM Diaphragms and Weighted Check Balls, Gaskets, Seals, Wear Pads, Nitrile O-Rings
476-245-365	Neoprene Diaphragms and Weighted Check Balls, Gaskets, Seals, Wear Pads, Nitrile O-Rings,
476-245-633	FKM Diaphragms, PTFE Check Balls, Gaskets and O-Rings, Seals, Wear Pads
476-043-635	PTFE Overlay Diaphragms, Check Balls, Gaskets and O-Rings, Seals, Neoprene Backup Diaphragm

# IMPORTANT SAFETY INFORMATION



**IMPORTANT**

Read these safety warnings and instructions in this manual completely, before installation and start-up of the pump. It is the responsibility of the purchaser to retain this manual for reference. Failure to comply with the recommendations stated in this manual will damage the pump, and void factory warranty.



**WARNING**

Take action to prevent static sparking. Fire or explosion can result, especially when handling flammable liquids. The pump, piping, valves, containers or other miscellaneous equipment must be grounded. (See page 11)



**WARNING**

This pump is pressurized internally with air pressure during operation. Always make certain that all bolting is in good condition and that all of the correct bolting is reinstalled during assembly.



**CAUTION**

Before pump operation, inspect all gasketed fasteners for looseness caused by gasket creep. Retorque loose fasteners to prevent leakage. Follow recommended torques stated in this manual.



**WARNING**

When used for toxic or aggressive fluids, the pump should always be flushed clean prior to disassembly.



**CAUTION**

Pump not designed, tested or certified to be powered by compressed natural gas. Powering the pump with natural gas will void the warranty.



**WARNING**

Before doing any maintenance on the pump, be certain all pressure is completely vented from the pump, suction, discharge, piping, and all other openings and connections. Be certain the air supply is locked out or made non-operational, so that it cannot be started while work is being done on the pump. Be certain that approved eye protection and protective clothing are worn all times in the vicinity of the pump. Failure to follow these recommendations may result in serious injury or death.



**WARNING**

Before maintenance or repair, shut off the compressed air line, bleed the pressure, and disconnect the air line from the pump. The discharge line may be pressurized and must be bled of its pressure.



**WARNING**

Airborne particles and loud noise hazards. Wear ear and eye protection.



**WARNING**

In the event of diaphragm rupture, pumped material may enter the air end of the pump, and be discharged into the atmosphere. If pumping a product which is hazardous or toxic, the air exhaust must be piped to an appropriate area for safe disposition.



**WARNING**

Use safe practices when lifting

## RECYCLING

Many components of SANDPIPER® AODD pumps are made of recyclable materials (see chart on page 11 for material specifications). We encourage pump users to recycle worn out parts and pumps whenever possible, after any hazardous pumped fluids are thoroughly flushed.

# Grounding The Pump

**⚠ WARNING ⚠**

*Take action to prevent static sparking. Fire or explosion can result, especially when handling flammable liquids. The pump, piping, valves, containers or other miscellaneous equipment must be grounded.*

One eyelet is fastened to the pump hardware.

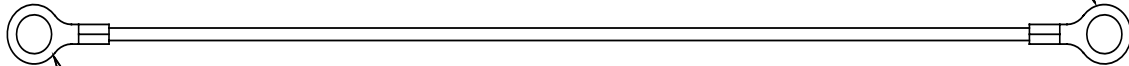

One eyelet is installed to a true earth ground.

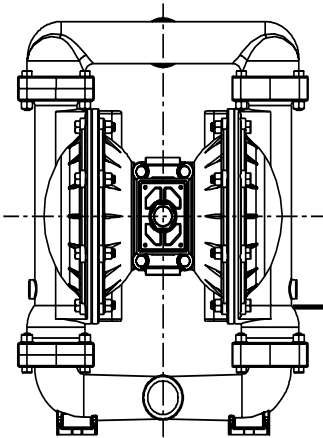

This 8 foot long (244 centimeters) Ground Strap, partnumber 920-025-000 can be ordered as a service item.

To reduce the risk of static electrical sparking, this pump must be grounded. Check the local electrical code for detailed grounding instruction and the type of equipment required, or in the absence of local codes, an industry or nationally recognized code having jurisdiction over specific installations.

## MATERIAL CODES THE LAST 3 DIGITS OF PART NUMBER

000	Assembly, sub-assembly; and some purchased items	353	Geolast; Color: BLACK	557	Conductive Polypropylene; Color: BLACK; Color Coded: SILVER
010	Cast Iron	354	Injection Molded #203-40 Santoprene- Duro 40D +/-5; Color: RED	558	Conductive HDPE; Color: BLACK Color Coded: SILVER
012	Powered Metal	355	Thermal Plastic	559	Conductive Polypropylene; Color: BLACK Color Coded: SILVER
015	Ductile Iron	356	Hytrel; Color: BLUE	570	Rulon II
020	Ferritic Malleable Iron	357	Injection Molded Polyurethane; Color: GREEN	580	Ryton
025	Music Wire	358	Urethane Rubber; Color: NATURAL (Some Applications)	590	Valox
080	Carbon Steel, AISI B-1112		(Compression Mold)	591	Nylatron G-S
100	Alloy 20	359	Urethane Rubber; Color: NATURAL	592	Nylatron NSB
110	Alloy Type 316 Stainless Steel	360	Nitrile Rubber; Color Coded: RED	600	PTFE (virgin material) Tetrafluorocarbon (TFE)
111	Alloy Type 316 Stainless Steel (Electro Polished)	361	Nitrile	601	PTFE (Bronze and moly filled)
112	Alloy C	363	FKM (Fluorocarbon). Color Coded: YELLOW	602	Filled PTFE
113	Alloy Type 316 Stainless Steel (Hand Polished)	364	E.P.D.M. Rubber. Color Coded: BLUE	603	Blue Gylon
114	303 Stainless Steel	365	Neoprene Rubber; Color Coded: GREEN	604	PTFE
115	302/304 Stainless Steel	366	Food Grade Nitrile; Color: WHITE	606	PTFE
117	440-C Stainless Steel (Martensitic)	368	Food Grade EPDM; Color: GRAY	607	Envelon
120	416 Stainless Steel (Wrought Martensitic)	370	Butyl Rubber Color Coded: BROWN	608	Conductive PTFE; Color: BLACK
123	410 Stainless Steel (Wrought Martensitic)	371	Philtane (Tuftane)	610	PTFE Encapsulated Silicon
148	Hardcoat Anodized Aluminum	374	Carboxylated Nitrile	611	PTFE Encapsulated FKM
149	2024-T4 Aluminum	375	Fluorinated Nitrile	632	Neoprene/Hytrel
150	6061-T6 Aluminum	378	High Density Polypropylene	633	FKM/PTFE
151	6063-T6 Aluminum	379	Conductive Nitrile; Color Coded: RED & SILVER	634	EPDM/PTFE
152	2024-T4 Aluminum (2023-T351)	384	Conductive Neoprene; Color Coded: GREEN & SILVER	635	Neoprene/PTFE
154	Almag 35 Aluminum	405	Cellulose Fibre	637	PTFE , FKM/PTFE
155	356-T6 Aluminum	408	Cork and Neoprene	638	PTFE , Hytrel/PTFE
156	356-T6 Aluminum	425	Compressed Fibre	639	Nitrile/TFE
157	Die Cast Aluminum Alloy #380	426	Blue Gard	643	Santoprene®/EPDM
158	Aluminum Alloy SR-319	440	Vegetable Fibre	644	Santoprene®/PTFE
159	Anodized Aluminum	465	Fibre	656	Santoprene Diaphragm and Check Balls/EPDM Seats
162	Brass, Yellow, Screw Machine Stock	500	Delrin 500	661	EPDM/Santoprene
165	Cast Bronze, 85-5-5-5	501	Delrin 570	666	FDA Nitrile Diaphragm, PTFE Overlay, Balls, and Seals
166	Bronze, SAE 660	502	Conductive Acetal, ESD-800; Color: BLACK	668	PTFE, FDA Santoprene/PTFE
170	Bronze, Bearing Type, Oil Impregnated	503	Conductive Acetal, Glass-Filled Color: BLACK; Color Coded: YELLOW		
175	Die Cast Zinc	505	Acrylic Resin Plastic		
180	Copper Alloy	506	Delrin 150		
305	Carbon Steel, Black Epoxy Coated	520	Injection Molded PVDF; Color: NATURAL		
306	Carbon Steel, Black PTFE Coated	521	Injection Molded Conductive PVDF; Color: BLACK; Color Coded: LIGHT GREEN		
307	Aluminum, Black Epoxy Coated	540	Nylon		
308	Stainless Steel, Black PTFE Coated	541	Nylon		
309	Aluminum, Black PTFE Coated	542	Nylon		
310	PVDF Coated	544	Nylon Injection Molded		
313	Aluminum, White Epoxy Coated	550	Polyethylene		
330	Zinc Plated Steel	551	Glass Filled Polypropylene; Color: BLACK		
331	Chrome Plated Steel	552	Unfilled Polypropylene; Color: NATURAL		
332	Aluminum, Electroless Nickel Plated	555	Polyvinyl Chloride		
333	Carbon Steel, Electroless Nickel Plated	556	Black Vinyl		
335	Galvanized Steel				
336	Zinc Plated Yellow Brass				
337	Silver Plated Steel				
340	Nickel Plated				
342	Filled Nylon				
351	Food Grade Santoprene; Color: NATURAL				

Delrin is a registered  
tradename of E.I. DuPont.

Gylon is a registered tradename  
of Garlock, Inc.

Nylatron is a registered tradename  
of Polymer Corp.

Santoprene is a registered tradename  
of Exxon Mobil Corp.

Rulon II is a registered tradename  
of Dixon Industries Corp.

Ryton is a registered tradename  
of Phillips Chemical Co.

Valox is a registered tradename  
of General Electric Co.

PortaPump, Tranquiliizer and SludgeMaster are  
registered tradenames of Warren Rupp, Inc.

# Composite Repair Parts List

ITEM NO.	PART NUMBER	DESCRIPTION	TOTAL RQD.
1	114.002.010.	Bracket Assembly, Intermediate	1
1	114.002.156.	Bracket Assembly, Intermediate	1
2	070.006.170.	Bearing, Sleeve	2
3	<b>720.004.360.</b>	<b>Seal, U-Cup</b>	<b>2</b>
4	<b>135.016.162.</b>	<b>Bushing Assembly, Threaded</b>	<b>2</b>
5	<b>560.001.360.</b>	<b>O-Ring</b>	<b>2</b>
6	<b>620.011.114.</b>	<b>Plunger, Actuator</b>	<b>2</b>
7	<b>095.073.001.</b>	<b>Pilot Valve Body Assy.<sup>1</sup></b>	<b>1</b>
7-A	<b>095.070.558.</b>	<b>Pilot Valve Body</b>	<b>1</b>
7-B	<b>755.025.000.</b>	<b>Sleeve (w/O-Ring)</b>	<b>1</b>
7-C	<b>560.033.360.</b>	<b>O-Ring (Sleeve)</b>	<b>4</b>
7-D	<b>775.026.000.</b>	<b>Spool (w/O-Ring)</b>	<b>1</b>
7-E	<b>560.023.360.</b>	<b>O-Ring (Spool)</b>	<b>2</b>
7-F	<b>675.037.080.</b>	<b>Retaining Ring</b>	<b>1</b>
8	<b>360.041.379.</b>	<b>Gasket, Valve Body</b>	<b>1</b>
9	530.036.000.	Muffler, Exhaust	1
10	<b>031.012.000.</b>	<b>Sleeve &amp; Spool Set</b>	<b>1</b>
11	095.043.010.	Body, Valve	1
	095.043.156.	Body, Valve	1
12	<b>132.014.358.</b>	<b>Bumper, Valve Spool</b>	<b>2</b>
13	165.011.010.	Cap, End	2
	165.011.157.	Cap, End	2
14	<b>360.010.425.</b>	<b>Gasket, End Cap</b>	<b>2</b>
15	<b>560.020.360.</b>	<b>O-Ring</b>	<b>6</b>
16	170.032.330.	Capscrew, Hex Head	8
17	170.045.330.	Capscrew, Hex Head	4
18	<b>360.048.425.</b>	<b>Gasket, Valve Body</b>	<b>1</b>
19	<b>132.002.360.</b>	<b>Bumper, Diaphragm</b>	<b>2</b>
20	<b>560.022.360.</b>	<b>O-Ring</b>	<b>2</b>
21	685.007.120.	Rod, Diaphragm	1
22	612.047.330.	Plate, Diaphragm — Inner	2
25	170.060.330.	Capscrew, Hex Head	16
26	170.024.330.	Capscrew, Hex Head	4
27	170.058.330.	Capscrew, Hex Head	4
28	170.030.330.	Capscrew, Hex Head	8
29	807.038.330.	Stud	4
30	807.039.330.	Stud	12
31	900.005.330.	Washer, Lock	4
32	900.003.330.	Washer, Lock	20
33	900.006.330.	Washer, Lock	12
34	545.007.330.	Nut, Hex	12
35	545.008.330.	Nut, Hex	12
36	545.005.330.	Nut, Hex	4
37	196.001.010.	Chamber, Inner	2
	196.001.157.	Chamber, Inner	2
38	115.053.080.	Bracket, Foot Mounting	2

ITEM NO.	PART NUMBER	DESCRIPTION	TOTAL RQD.
39	<b>560.047.360.</b>	<b>O-Ring</b>	<b>2</b>
	560.060.611.	O-Ring	2
40	685.032.080.	Rod, Connector	1
41	<b>722.035.110.</b>	<b>Seat Assembly, Ball Check Valve</b> <i>(for use with PTFE balls only)</i>	<b>2</b>
	<b>722.035.112.</b>	<b>Seat Assembly, Ball Check Valve</b> <i>(for use with PTFE balls only)</i>	<b>2</b>
	722.097.110.	Seat Assembly	
	722.097.112.	Seat Assembly	
42	286.007.360.	Diaphragm	2
	<b>286.007.364.</b>	<b>Diaphragm</b>	<b>2</b>
	<b>286.007.365.</b>	<b>Diaphragm</b>	<b>2</b>
	286.007.363.	Diaphragm	2
	286.007.366.	Diaphragm	2
	286.007.356.	Diaphragm	2
	286.007.354.	Diaphragm	2
43	196.035.010.	Chamber, Diaphragm — Outer	2
	196.035.110.	Chamber, Diaphragm — Outer	2
	196.035.112.	Chamber, Diaphragm — Outer	2
	196.035.156.	Chamber, Diaphragm — Outer	2
44	612.039.010.	Plate Assembly, Diaphragm	2
	612.097.110.	Plate Assembly, Diaphragm	2
	612.097.112.	Plate Assembly, Diaphragm	2
	612.039.157.	Plate Assembly, Diaphragm	2
45	312.033.010.	Elbow, Manifold	2
	312.033.110.	Elbow, Manifold	2
	312.033.112.	Elbow, Manifold	2
	312.033.156.	Elbow, Manifold	2
46	334.025.010.	Flange, Threaded	2
	334.025.110.	Flange, Threaded	2
	334.025.112.	Flange, Threaded	2
	334.025.156.	Flange, Threaded	2
47	334.026.010.	Flange, Porting — Suction	1
	334.026.110.	Flange, Porting — Suction	1
	334.026.112.	Flange, Porting — Suction	1
	334.026.156.	Flange, Porting — Suction	1
48	334.027.010.	Flange, Porting — Discharge	1
	334.027.110.	Flange, Porting — Discharge	1
	334.027.112.	Flange, Porting — Discharge	1
	334.027.156.	Flange, Porting — Discharge	1
49	518.027.010.	Manifold	1
	518.027.110.	Manifold	1
	518.027.112.	Manifold	1
	518.027.156.	Manifold	1
<b>ITEM</b>			<b>TOTAL</b>



NO.	PART NUMBER	DESCRIPTION	RQD.
50	<b>360.049.425.</b>	<b>Gasket, Flange</b>	<b>2</b>
	360.049.603.	Gasket, Flange	2
51	360.050.379.	Gasket, Manifold	4
	360.050.384.	Gasket, Manifold	4
	360.050.608.	Gasket, Manifold	4
52	618.003.110.	Pipe Plug	4
	618.003.112.	Plug, Pipe	4
	618.003.330.	Plug, Pipe (Cast Iron and Aluminum wetted end)	4
53	675.013.360.	Ring, Sealing	2
	<b>675.013.365.</b>	<b>Ring, Sealing</b>	<b>2</b>
	675.013.363.	Ring, Sealing	2
	675.013.364.	Ring, Sealing	2
	675.013.600.	Ring, Sealing	2
54	050.017.360W.	Ball, Check Valve	4
	050.017.364W.	Ball, Check Valve	4
	050.017.354.	Ball, Check Valve	4
	<b>050.017.365W.</b>	<b>Ball, Check Valve</b>	<b>4</b>
	050.018.600.	Ball, Check Valve	4
55	115.057.080.	Bracket, Foot Mtg.	2
56	900.004.330.	Washer, Lock	2
57	545.004.330.	Nut, Hex	2
<b>58</b>	<b>286.020.604.</b>	<b>Diaphragm</b>	<b>2</b>
59	901.025.115.	Washer	2
62	618.003.330.	Pipe Plug (air end)	2
63	570.009.360.	Pad, Wear (Not used on PTFE units)	2
	570.009.363.	Pad, Wear	2
	570.009.364.	Pad, Wear	2
	570.009.365.	Pad, Wear	2
NOT SHOWN:			
	031.019.010.	(Cast Iron Center)	(1)
	031.019.156.	(Aluminum Center)	(1)
		Includes items 10, 11, 12, 13, 14, 15, 16	

Available in kit form. Order P/N 031.055.000., which also includes items 6, 8, 18, 61.

\*\*BOTTOM PORTING is recommended for pumping material containing solids which could settle out in the pumping chambers.

\*\*TOP PORTING is recommended if there is a possibility of entrapped air vapors inhibiting the pumping action.

# Composite Repair Drawing

A = These Items Available in Kit Form Only.  
 Order Angle Valve Kit P/N 475-102-000.

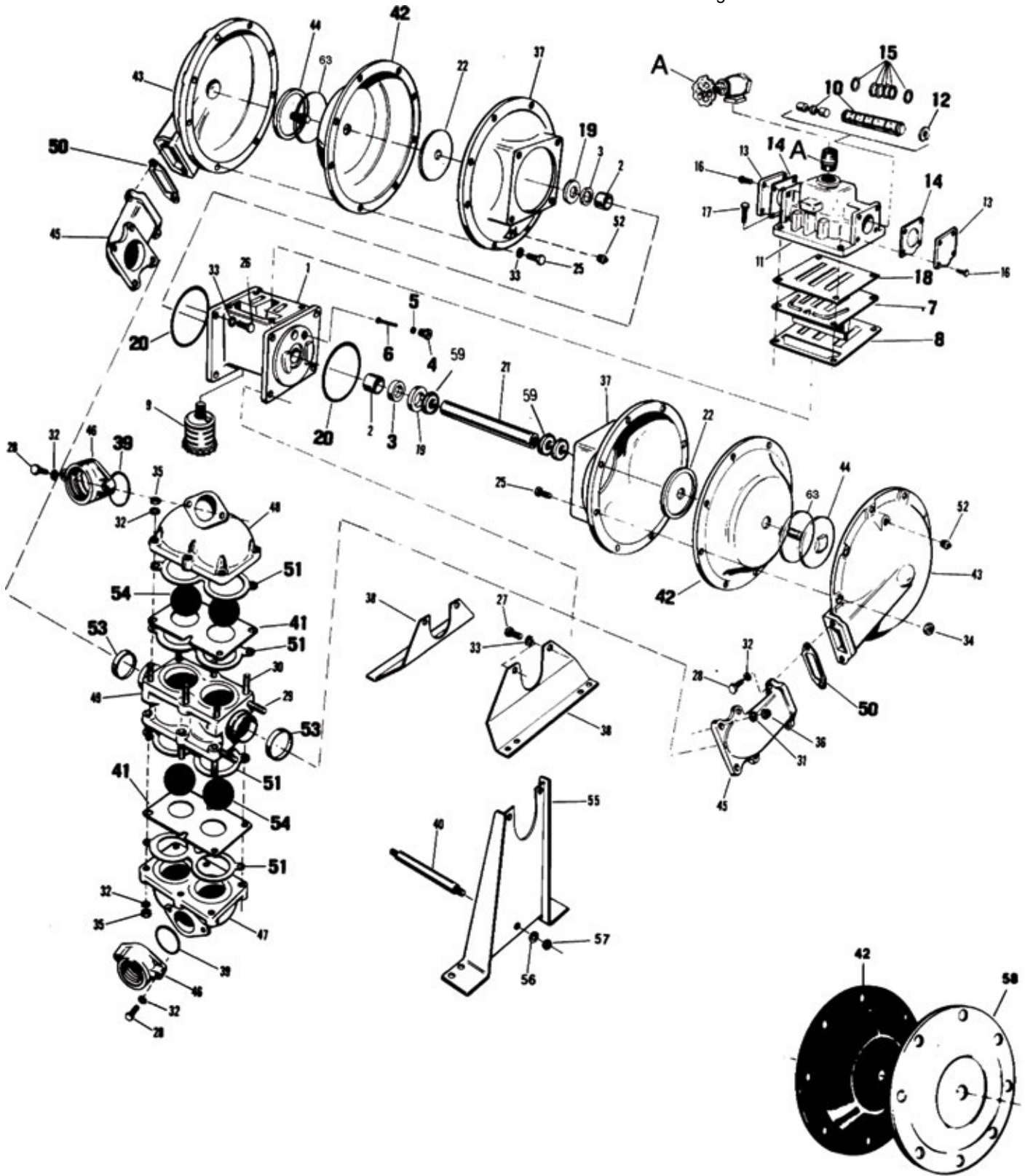

# **WARREN RUPP, INC.<sup>®</sup>**

## **Declaration of Conformity**

**Manufacturer:**  
**Warren Rupp, Inc.<sup>®</sup>, 800 N. Main Street**  
**Mansfield, Ohio, 44902 USA**

certifies that Air-Operated Double Diaphragm Pump Series: HDB, HDF, M Non-Metallic, S Non-Metallic, M Metallic, S Metallic, T Series, G Series, RS Series U Series, EH and SH High Pressure, W Series, SMA and SPA Submersibles, and Tranquilizer Surge Suppressors comply with the European Community Directive 2006/42/EC on Machinery, according to Annex VIII. This product has used Harmonized Standard EN809:1998+A1:2009, Pumps and Pump Units for Liquids - Common Safety Requirements, to verify conformance.

*David Roseberry*  
Signature of authorized person

October 20, 2005  
Date of issue

David Roseberry  
Printed name of authorized person

Engineering Manager  
Title

Revision Level: F

April 19, 2012  
Date of revision



# **WARREN RUPP, INC.**

## **EC Declaration of Conformity**

In accordance with ATEX Directive 94/9/EC,  
Equipment intended for use in potentially explosive environments.

**Manufacturer:**

Warren Rupp, Inc.®  
A Unit of IDEX Corporation  
800 North Main Street  
P.O. Box 1568  
Mansfield, OH 44902 USA

**Applicable Standard:**

EN13463-1: 2009  
EN13463-5: 2011

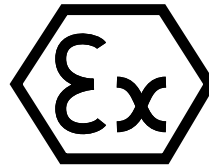

**EN 60079-25: 2011**

For pumps equipped with Pulse Output ATEX Option  
Quality B.V. (0344)

**AODD Pumps and Surge Suppressors**

For Type Examination Designations, see page 2 (back)

**AODD (Air-Operated Double Diaphragm) Pumps**

EC Type Examination Certificate No. Pumps: KEMA 09ATEX0071 X

DEKRA Certification B.V. (0344)  
Meander 1051  
6825 MJ Arnhem  
The Netherlands

**SANDPIPER**®  
A WARREN RUPP, INC. BRAND

**Tranquilizer**®

DATE/APPROVAL/TITLE:  
13 May 2015

*David Roseberry*  
David Roseberry, Engineering Manager

**IDEX**  
FLUID & METERING

# WARREN RUPP, INC.

## EC Declaration of Conformity

### ATEX Summary of Markings

Type	Marking	Listed In	Non-Conductive Fluids	
Pump types, S1F, S15, S20, and S30 provided with the pulse output option	II 2 G Ex ia c IIC T5 Gb II 3/2 Ex ia c IIC T5 Gc/Gb II 2 D Ex ia c IIIC T100°C Db	KEMA 09ATEX0071 X CE 0344	KEMA 09ATEX0071 X KEMA 09ATEX0071 X KEMA 09ATEX0071 X	No Yes Yes
Pump types, S1F, S15, S20, and S30 provided with the integral solenoid option	II 2 G Ex mb IIC T5 Gb II 3/2 G Ex mb IIC T5 Gc/Gb II 2 D Ex tDa 21 IP65 T100°C Db	KEMA 09ATEX0071 X CE 0344	KEMA 09ATEX0071 X KEMA 09ATEX0071 X KEMA 09ATEX0071 X	No Yes Yes
Pump types, HDB1½, HDB40, HDB2, HDB50, HDB3, HDF1, HDF25, HDF2, HDF3M, PB¼, S05, S1F, S15, S20, S30, SB1, SB25, ST1½, ST40, G15, G20, and G30, without the above listed options, no aluminum parts	II 1 G c T5 II 3/1 G c T5 II 1 D c T100°C I M1 c I M2 c	KEMA 09ATEX0071 X KEMA 09ATEX0072 X CE 0344	KEMA 09ATEX0071 X KEMA 09ATEX0071 X KEMA 09ATEX0071 X KEMA 09ATEX0071 X KEMA 09ATEX0072 X	No Yes Yes No Yes
Pump types, DMF2, DMF3, HDB1½, HDB40, HDB2, HDB50, HDB3, HDF1, HDF25, HDF2, HDF3M, PB¼, S05, S1F, S15, S20, S30, SB1, SB25, SE½, ST1, ST25, ST1½, ST40, U1F, G05, G1F, G15, G20, and G30	II 2 G c T5 II 3/2 G c T5 II 2 D c T100°C	KEMA 09ATEX0072 X CE	KEMA 09ATEX0072 X KEMA 09ATEX0072 X KEMA 09ATEX0072 X	No Yes Yes
Surge Suppressors all types	II 2 G T5 II 3/2 G T5 II 2 D T100°C	KEMA 09ATEX0073 CE	KEMA 09ATEX0073 KEMA 09ATEX0073 KEMA 09ATEX0073	No Yes Yes

EC Type Certificate No. Pumps: KEMA 09ATEX0071 X  
Type Certificate No. Pumps: KEMA 09ATEX0072 X  
Type Certificate No. Suppressors: KEMA 09ATEX0073

Pumps marked with equipment Category II 3/1 G (internal 3 G / external 1 G), 1D, M1 and M2 when used for non-conductive fluids. The pumps are Category II 1 G when used for conductive fluids.

Pumps and surge suppressors are Category II 2 G when pumping conductive fluids. When non-conductive fluids are pumped, models with non-conductive diaphragms that have a fluid contact surface area above 400cm<sup>2</sup>, are restricted to Category II 3 G internally and Category II 2 G for external surfaces. The following models are restricted:

ST1 1/2, ST40

S15 and S20 ATEX-compliant Nonmetallic equipped with Synthesis (One-Piece Bonded PTFE) diaphragms

S15, S20, G15, and G20 Metallic equipped with Synthesis (One-Piece Bonded PTFE) diaphragms

S30 and G30 Metallic

HDB1 1/2 and HDB2 equipped with Synthesis (One-Piece Bonded PTFE) diaphragms

HDB3, HDB4, HDF3, HDF3M, HDF4, and HDF4M

TA3 and TA80

**IDEX**  
FLUID & METERING